

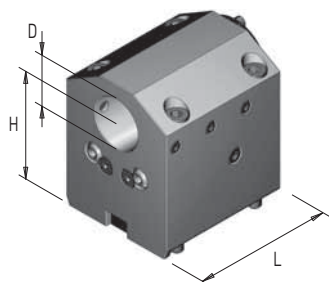

MODELLI / Models
LYNX220 (M, MS, LM)
PUMA MX 1600 (ST)

MACCHINE COMPATIBILI / Compatibility machines
Samsung PL 1600M/MC
Hardinge T-42 super precision

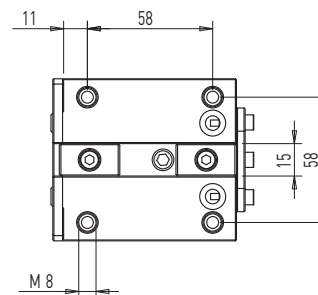
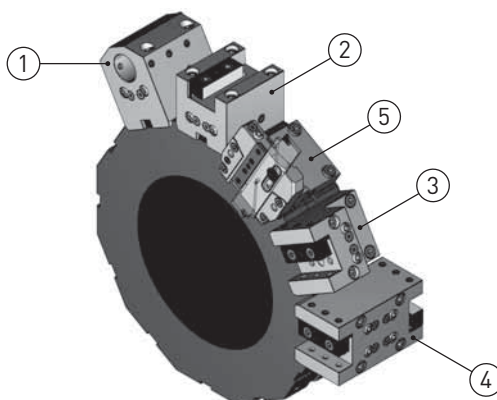

1

Art. / Code	Art. / Code DOOSAN	D	H	L	Coolant IN	Coolant OUT
7D5C32 H65	/	32	65	85	✓	✓
7D5C32 R H65	/	32	65	85	✓	✓

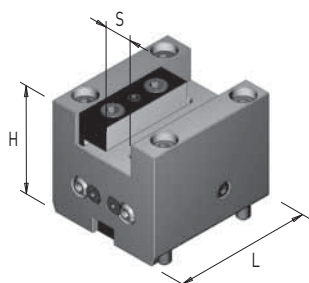

2

Art. / Code	Art. / Code DOOSAN	S	H	L	Coolant IN	Coolant OUT
8D5C40	/	20x20	65	85	✗	✓

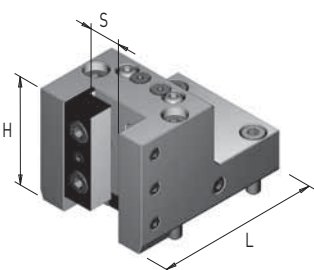

3

Art. / Code	Art. / Code DOOSAN	S	H	L	Coolant IN	Coolant OUT
8D5V40	/	20x20	65	102	✗	✓

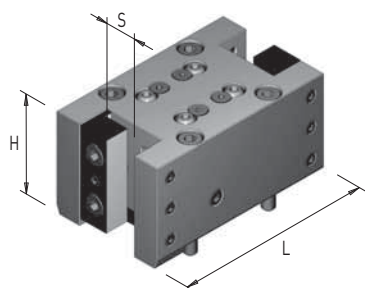

4

Art. / Code	Art. / Code DOOSAN	S	H	L	Coolant IN	Coolant OUT
8D5D40	/	20x20	60	124	✗	✓

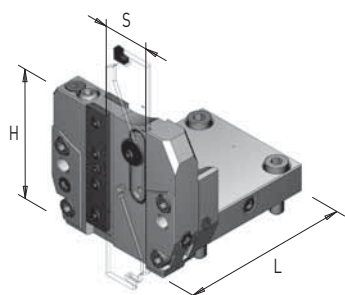

5

Art. / Code	Art. / Code DOOSAN	S	H	L	Coolant IN	Coolant OUT
8D5B32	/	ISCAR32	79	105	✓	✓